



BERNINA Q 24 | Q 20

User Manual



Edition notice

Text, Setting and Layout

BERNINA International AG

Photos

Patrice Heilmann, Winterthur

Order number

2015/06 en 036 0625.2.04

2nd Edition

Copyright

2014 BERNINA International AG

All rights reserved: For technical reasons and for the purpose of product improvements, changes concerning the features of the machine can be made at any time and without advance notice. The supplied accessories can vary depending on the country of delivery.

Contents

IMPORTANT SAFETY INSTRUCTIONS	9
1 My BERNINA	12
1.1 Introduction	12
1.2 Further information	12
1.3 Key to signs	12
1.4 BERNINA Q 20 Table version	13
Front view	13
Side view	14
Back view	15
1.5 BERNINA Q 24 / Q 20 Frame version	16
Front view	16
Side view	17
Back view	18
1.6 Provided accessories	19
Use of the power cable (only in USA/Canada)	21
Foot control (only USA/Canada)	21
1.7 Optional accessories (optional)	21
1.8 Frame	25
Overview concerning sizes	25
Delivery content Frame	25
1.9 Table	26
Overview concerning sizes	26
Delivery content Table	26
1.10 Overview Sewing menu Q 24 / Q 20 Frame version	27
1.11 Overview Sewing menu Q 20 Table version	27
1.12 Overview Selection menu	28
1.13 Buttons and icons	28
1.14 Needle, Thread, Fabric	29
Needle types	29
Thread selection	29
Example for needle description	30
Needle/thread combination	31
2 Overview Frame and Table	32
2.1 Overall view Frame	32
2.2 Overall view Table	33
3 Preparation	34
3.1 Connecting the Frame machine and switching on	34
Attaching the front handles and adjusting the locking levers	34
Adjusting the handles	36
Connecting the machine	36
Switching the machine on	36
3.2 Connecting the Table machine and switching on	37

	Attaching the foot control.....	37
	Connecting the machine.....	37
	Switching the machine on.....	37
3.3	Foot control (Table machine).....	37
	Moving the fabric.....	37
3.4	Spool holder.....	38
	Attaching the spool holder.....	38
	Positioning the spool disc.....	39
	Using a spool net.....	40
3.5	Presser foot.....	40
	Setting the presser foot position.....	40
	Changing the presser foot.....	40
3.6	Needle and stitch plate.....	41
	Setting the needle stop up/down (permanent).....	41
	Adjusting the needle stop via the foot control (only Table machine).....	41
	Changing the needle.....	41
	Changing the stitch plate.....	41
3.7	Threading.....	42
	Threading preparation.....	42
	Threading the upper thread.....	42
	Threading the double needle (optional accessory).....	46
	Winding the bobbin.....	49
	Setting the bobbin thread tension.....	51
	Threading the bobbin thread.....	52
	Indicating/adjusting the filling level of the bobbin thread.....	53
3.8	Calling up the Help.....	54
3.9	Calling up the Tutorial.....	54
4	Setup-Program.....	55
4.1	Overview Setup-Program.....	55
4.2	Programming the number of securing stitches.....	55
4.3	Selecting personal settings.....	55
4.4	Monitoring functions.....	56
	Activating the upper thread indicator.....	56
	Activating the lower thread indicator.....	57
4.5	Activating the audio signals.....	57
4.6	Machine settings.....	58
	Overview Machine settings.....	58
	Selecting the language.....	58
	Adjusting the brightness of the display.....	59
	Adjusting the sewing light.....	59
	Calibrating the display.....	60
	Back to basic setting.....	61
	Updating software.....	61
	Restoring saved data.....	62
	Cleaning the machine.....	63
	Lubricating the machine.....	63
	Calling up the Service-Program.....	64

	Verifying the software version.....	64
	Review of the total number of stitches.....	65
	Registering details of the dealer.....	65
	Saving Service data.....	66
5	Quilting on the Frame machine.....	67
5.1	BSR Function.....	67
	BSR1.....	67
	Quilting in BSR1 mode.....	67
	BSR2.....	68
	Quilting in BSR2 mode.....	68
	BSR3.....	69
	Basting in BSR3 mode.....	69
	Manual mode.....	70
	Quilting in the manual mode.....	70
5.2	Programmable functions.....	71
	Programming the handle buttons.....	71
	Programming no function.....	72
	Starting/Stopping the machine.....	72
	Sewing securing stitches.....	72
	Raising/Lowering the needle.....	72
	Presser foot up/down.....	72
	Reducing the basic stitching speed.....	72
	Increasing the basic stitching speed.....	72
5.3	Adjusting the upper thread tension.....	72
5.4	Creating a user profile.....	73
5.5	Deleting a user profile.....	73
5.6	Using the calculator.....	74
5.7	Resetting the stitch counter to 0.....	74
5.8	Using the eco mode.....	74
6	Quilting on the Table machine.....	75
6.1	BSR Function.....	75
	BSR1.....	75
	Quilting in BSR1 mode.....	75
	BSR2.....	76
	Quilting in BSR2 mode.....	76
	BSR3.....	77
	Basting in BSR3 mode.....	77
	Manual mode.....	78
	Quilting in the manual mode.....	78
6.2	Programmable functions.....	79
	Programming back kick on the foot control.....	79
	Programming no function.....	79
	Sewing securing stitches.....	79
	Needle up-/down.....	80
	Presser foot up/down.....	80
6.3	Adjusting the upper thread tension.....	80
6.4	Creating a user profile.....	80

6.5	Deleting a user profile.....	81
6.6	Using the calculator.....	81
6.7	Resetting the stitch counter to 0.....	81
6.8	Using the eco mode.....	81
7	Attachment.....	83
7.1	Amount of bobbin thread.....	83
7.2	Servicing and cleaning the machine.....	84
	Cleaning the hook.....	84
	Cleaning the bobbin case.....	84
	Cleaning the display.....	85
	Lubricating the machine.....	85
7.3	Servicing and cleaning the Frame and the carriage.....	85
	Checking and cleaning the Frame.....	85
	Checking and cleaning the carriage.....	86
7.4	Maintenance, Cleaning and Transport Table.....	86
	Cleaning and care instruction.....	86
	Moving or transporting the Table.....	86
7.5	Troubleshooting.....	87
7.6	Error messages.....	90
7.7	Storage and disposal.....	92
	Storing the machine.....	92
	Dispose of the machine.....	92
7.8	Technical specifications.....	93
	Index.....	94

IMPORTANT SAFETY INSTRUCTIONS

Please be aware of the following basic safety instructions when using your machine. Before using this machine, read instruction manual carefully.

DANGER!

To reduce the risk of electrical shock:

- Never leave the machine unattended as long as it is plugged in.
- Always unplug the machine from the electrical outlet immediately after using and before cleaning.

Protection against LED radiation:

- Do not view the LED light directly with optical instruments (e.g. magnifier). The LED light corresponds with protection class 1M.

WARNING

To reduce the risk of burns, fire, electric shock or injury to persons:

- Use this machine only for purposes as described in this manual.
- Do not use the machine outdoor.
- Do not use this machine as a toy. Close attention is necessary when this machine is used by or near children.
- The machine can be used by children older than 8 or by people with reduced physical, sensory or mental capabilities or if there is a lack of experience and knowledge how to operate the machine as long as they are supervised or have been given instruction concerning the responsible use of the appliance and are aware of the involved risks.
- Children are not allowed to play with this machine.

- Cleaning and maintenance work must not be carried out by children unless they are supervised.
- Never operate this machine if it has a damaged cord or plug, if it is not working properly, if it has been dropped or damaged, or dropped into water. Contact the nearest authorized BERNINA dealer to arrange further details.
- Only use accessory recommended by the manufacturer.
- Don't use this machine when the ventilation openings are blocked. Keep the ventilation openings free from the accumulation of lint, dust and loose cloth.
- Never insert any objects into any openings of the machine.
- Do not operate the machine where aerosol products (sprays) or oxygen are being used.
- Keep fingers away from all moving parts. Special care is required around the sewing needle.
- Turn power switch to «0» (off) when making any adjustments in the needle area, such as threading the needle, changing the needle, threading the lower thread or changing the presser foot, etc.
- Do not use bent needles.
- Always use the original BERNINA stitch plate. The wrong stitch plate can cause needle breakage.
- To disconnect, turn power switch to «0» (off), then remove the plug from the outlet. Do not unplug by pulling the cord, instead grasp the plug to pull it from the outlet.
- Always disconnect the power plug from the electrical outlet when the covers are removed or opened, when the machine is lubricated or during any other maintenance adjustments mentioned in the instruction manual (disconnect the power plug).

- This machine is provided with double insulation (except USA / Canada). Use only identical replacement parts. See instructions for Servicing of double-insulated products.

Servicing double-insulated products

In a double-insulated product two systems of insulation are provided instead of grounding. No grounding means is provided on a doubleinsulated product, nor should a means for grounding be added to the product. Servicing a double-insulated product requires extreme care and knowledge of the system and should be done only by qualified service personnel. Replacement parts for a double-insulated product must be identical to the original parts in the product. A double-insulated product is marked with the words: «Double Insulation» or «double-insulated».

The symbol may also be marked on the product.

SAVE THESE INSTRUCTIONS!

Appropriate use

Your BERNINA machine is built and designed for ambitious hobby practice. It answers the purpose of quilting fabrics as described in this instruction manual. Any other usage is not intended. BERNINA doesn't assume liability resulting from inappropriate application.

1 My BERNINA

1.1 Introduction

With the BERNINA Q 20 / Q 24 (Frame-Machine) / BERNINA Q 20 (Table-Machine) large-format quilt projects can be created. Any personal settings can be saved and referred to at any time.

In addition to this instruction manual, 2 Help Program are provided in the display.

The **Tutorial** provides information and explanations covering various aspects of quilting.

The **Help Program** contains information concerning the individual quilting functions and applications in the display.

1.2 Further information

In addition to this instruction manual of your BERNINA Q 20 / Q 24 (Frame-Machine) / BERNINA Q 20 (Table-Machine), following information products are enclosed:

- Instructional DVD for the Longarm machine
- Accessory catalog

The latest version of your instruction manual as well as additional information in connection with quilting can be found on our website <http://www.bernina.com>

1.3 Key to signs



DANGER

Labels a danger with a high risk which can lead to death or severe injury unless it is avoided.



WARNING

Labels a danger with a medium risk which can lead to death or severe injury unless it is avoided.



CAUTION

Labels a danger with a low risk which can lead to light or medium injury unless it is avoided.

NOTICE

Labels a danger which can end up with damage unless it is avoided.



Tips provided by BERNINA **Quilt experts** can be found next to this sign.

By means of illustration, sample pictures are used in this instruction manual. The machines as well as the accessories shown in the pictures may vary from the delivery content of your machine.

1.4 BERNINA Q 20 Table version

Front view



- | | | | |
|---|------------------|---|----------------------|
| 1 | Presser foot | 6 | Thread guide |
| 2 | Needle threader | 7 | Display |
| 3 | Thread guide | 8 | Thread guide |
| 4 | Thread regulator | 9 | Ventilation openings |
| 5 | Take up lever | | |

Side view

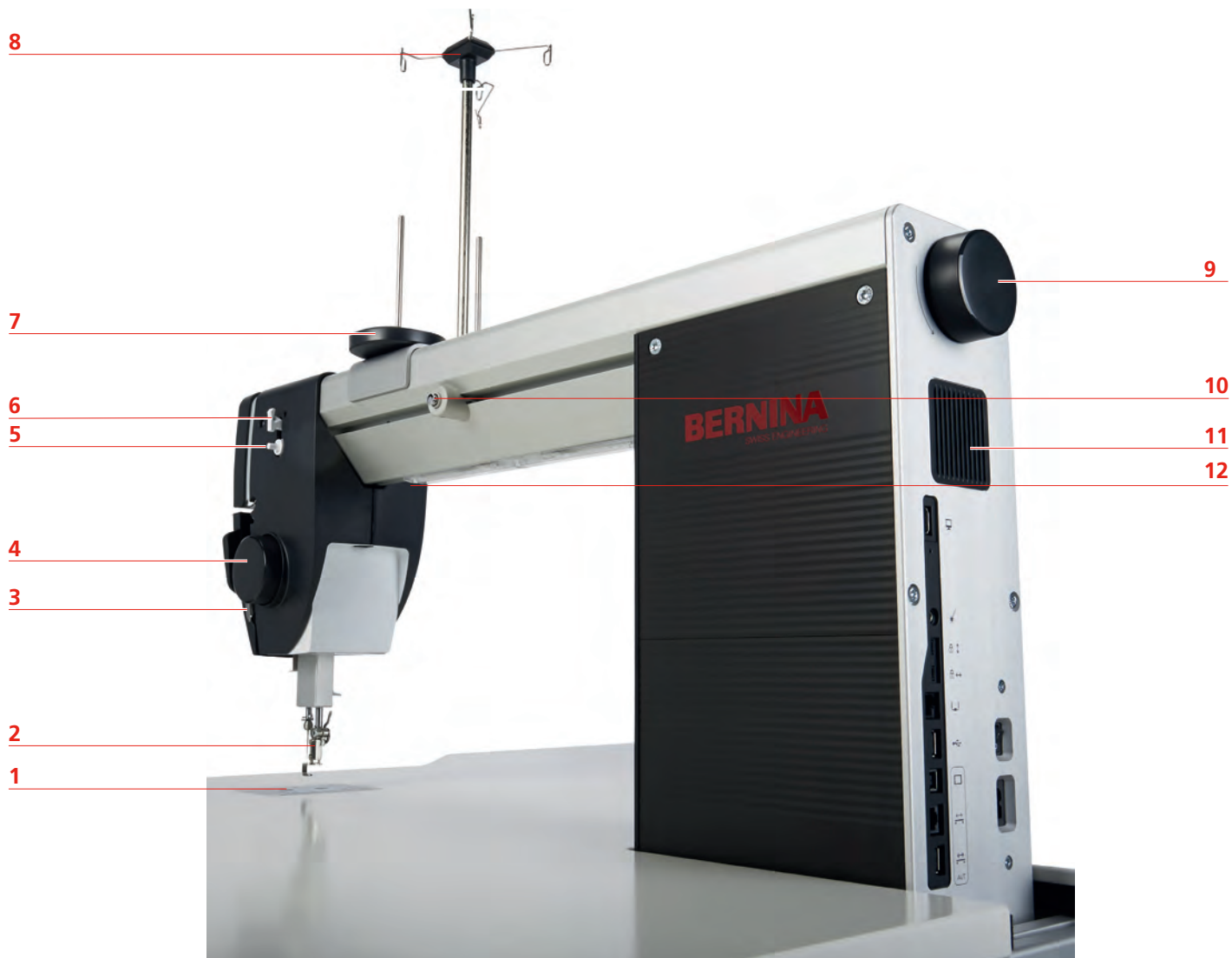

- | | | | |
|---|------------------|----|----------------------|
| 1 | Stitch plate | 7 | Spool holder |
| 2 | Presser foot | 8 | Thread guide bar |
| 3 | Thread regulator | 9 | Handwheel |
| 4 | Handwheel | 10 | Thread pre-tension |
| 5 | Bobbin winder | 11 | Ventilation openings |
| 6 | Thread cutter | 12 | Sewing light |

Back view



- | | | | |
|---|-----------------------------------|----|-----------------------------|
| 1 | Connection for motorized carriage | 7 | Connection for laser light |
| 2 | Connection for motorized carriage | 8 | Connection for back display |
| 3 | Connection for control unit | 9 | Locking horizontal axis |
| 4 | Connection USB | 10 | Main switch |
| 5 | Connection for rear handle | 11 | Connection for power cable |
| 6 | Locking vertical axis | | |

1.5 BERNINA Q 24 / Q 20 Frame version

Front view



- | | | | |
|---|---------------------------|----|--------------------------|
| 1 | Bobbin cover | 7 | Upper left thread guide |
| 2 | Stitch plate | 8 | Upper right thread guide |
| 3 | Locking lever for handles | 9 | Sewing light |
| 4 | Thread cutter | 10 | Handle right |
| 5 | Lower thread guide | 11 | Handle left |
| 6 | Thread guide slot | | |

Side view



- 1 Ventilation openings
- 2 Handwheel
- 3 Spool holder right

- 4 Thread guide bar with loops
- 5 Spool holder left
- 6 Locking lever for handle

Back view



- | | | | |
|---|-----------------------------------|----|-----------------------------|
| 1 | Connection for motorized carriage | 7 | Locking vertical axis |
| 2 | Connection for motorized carriage | 8 | Connection for back display |
| 3 | Connection for control unit | 9 | Connection for laser light |
| 4 | Connection USB | 10 | Main switch |
| 5 | Connection for rear handle | 11 | Connection for power cable |
| 6 | Locking horizontal axis | | |

1.6 Provided accessories

More accessories can be found at www.bernina.com

Illustration	Name	Purpose
	Accessory box	The accessories are stored in the accessory box.
	Darning foot No. 9	This foot is an all-round foot suitable for both free motion quilting and quilting with pantograph or pattern boards.
	Front handles (only Frame machine)	The machine is operated via the handles.
	Thread lubricating unit	The lubricating unit, a collecting container when filled with silicon, helps to improve the stitch quality when working with difficult threads such as metallic threads or when using adhesive sprays or iron-on stabilizers.
	Silicone oil	The thread lubricating unit is filled with silicone oil.
	2 Thread discs	The thread disc supports a regular unwinding of the thread from the thread spool and also stabilizes small thread spools on the vertical spool pin.
	5 Bobbins in the accessory, 1 bobbin in the bobbin case	The bobbins are filled with the bobbin thread.
	2 Spool stabilizers	The spool stabilizers stabilize big thread spools when they are used on the vertical spool holder.

















Illustration	Name	Purpose
	Seam ripper	The seam ripper is an indispensable aid to undo seams.
	Net white	The white spool net can be slid on a large thread spool while being used.
	Net red	The red spool net can be slid on a small thread spool while being used.
	5 Needles 130/705 H PRO 100	The needles are suitable for any common applications.
	Manual threader	The manual threader is used for threading the double needle.
	Screwdriver red	The red screwdriver is supplied as an all-round tool.
	Torx screwdriver T6	Use the torx screwdriver T6 to change the needle.
	Torx screwdriver T10 (Frame machine)	For frame assembly.
	Torx screwdriver T20 (Frame machine)	For frame assembly.
	Torx screwdriver T25	For frame assembly.
	Torx screwdriver T30 (Frame machine)	For frame assembly.
	Brush	Use the brush to clean the hook and the hook race area.
	Microfibre cleaning cloth	Use to clean the display.
	Lubricator	Use the lubricator to oil the hook.

Illustration	Name	Purpose
	Bobbin thread tension gauge	With this device, the tension of the bobbin thread can be adjusted. The bobbin thread tension is indicated in millinewton (mN). The recommended bobbin thread tension is 220 mN.
	Power cable	The power cable connects the machine with the power supply system.
	Foot control (only Table machine)	Via the foot control the machine can be started and stopped. As well the speed of the machine is controlled via the foot control.

Use of the power cable (only in USA/Canada)

The machine has a polarized plug (one blade wider than the other). To reduce the risk of electrical shock, this plug is intended to fit in a polarized outlet only one way. If the plug does not fit fully in the outlet, reverse the plug. If it still does not fit, contact a qualified electrician to install the proper outlet. Do not modify the plug in any way!





Foot control (only USA/Canada)

Always use the foot control of the type LV1 in combination with the BERNINA Q 20 (Table machine) .

1.7 Optional accessories (optional)

BERNINA offers a wide and continually increasing range of optional accessories for the longarm machines. Due to this accessories you can let your creativity run free, enhance your quilting experience or work even more efficiently. Get further information at your BERNINA dealer's. Hereinafter you will find an extract of possible accessories. Please find the complete and always up to date list at www.bernina.com.

Optional presser feet

Illustration	Number	Name	Purpose
	15	Embroidery foot	Suitable for free motion quilting; it simplifies quilting over extremely uneven or thickened areas such as multiple seams or appliques due to the slightly thicker edges.
	24	Free motion embroidery foot	The foot is especially suitable for quilting detailed work, such detailed work like micro stippling. The foot allows a better view of the area to be quilted in front of the needle and the foot is complementary when using the MicroWork handles (Optional accessory).
	26	Embroidery foot in drop shape	The foot is especially suitable for dense quilting such as thread painting. The rounded bottom side of the foot prevents the thread from being damaged, even if the same area is quilted several times.
	29	Quilting foot	Due to the transparent sole and the large stitch hole, this foot is especially suitable when a precise positioning is required while quilting, such as free motion stitch-in-the-ditch around appliques or free motion quilting.
	44C	Echoquilting and CutWork foot	The large transparent sole of the foot with engraved crosshairs provides precise positioning of the pattern when working with automated systems.
	96	Ruler foot	Specialized foot for quilting with ¼ inch rulers.

Optional accessories Q machine

Illustration	Name	Purpose
	Pantograph Kit	The Pantograph Kit contains everything you need to sew edge-to-edge quilt patterns simply and easily. Create beautiful quilt patterns by following purchased paper patterns or self-created patterns.
	Ruler work Kit	The Ruler-Work-Kit serves as an aid when a special form or an exact line are to be sewn.
	Spool pin vertical	Additional spool pin when working with more than two thread spools.
	Spool pin horizontal	Is used when working with thread which is parallel-wound.

Optional accessory Frame

Illustration	Name	Purpose
	Casters	With the help of casters the Frame can be moved easily.
	Batting rail	The batting rail holds the roll of batting. The batting can be stored and positioned directly onto the quilt.
	Shelves	Due to the additional shelving, additional storage space is obtained.
	Horizontal and vertical channel locks	With the help of the channel locks, the machine will be locked horizontally or vertically and perfect straight lines can be quilted.
	Hydraulic height adjustment (Adjustment track: 300 mm)	The Frame is hydraulically adjustable in height.

1.8 Frame

Overview concerning sizes

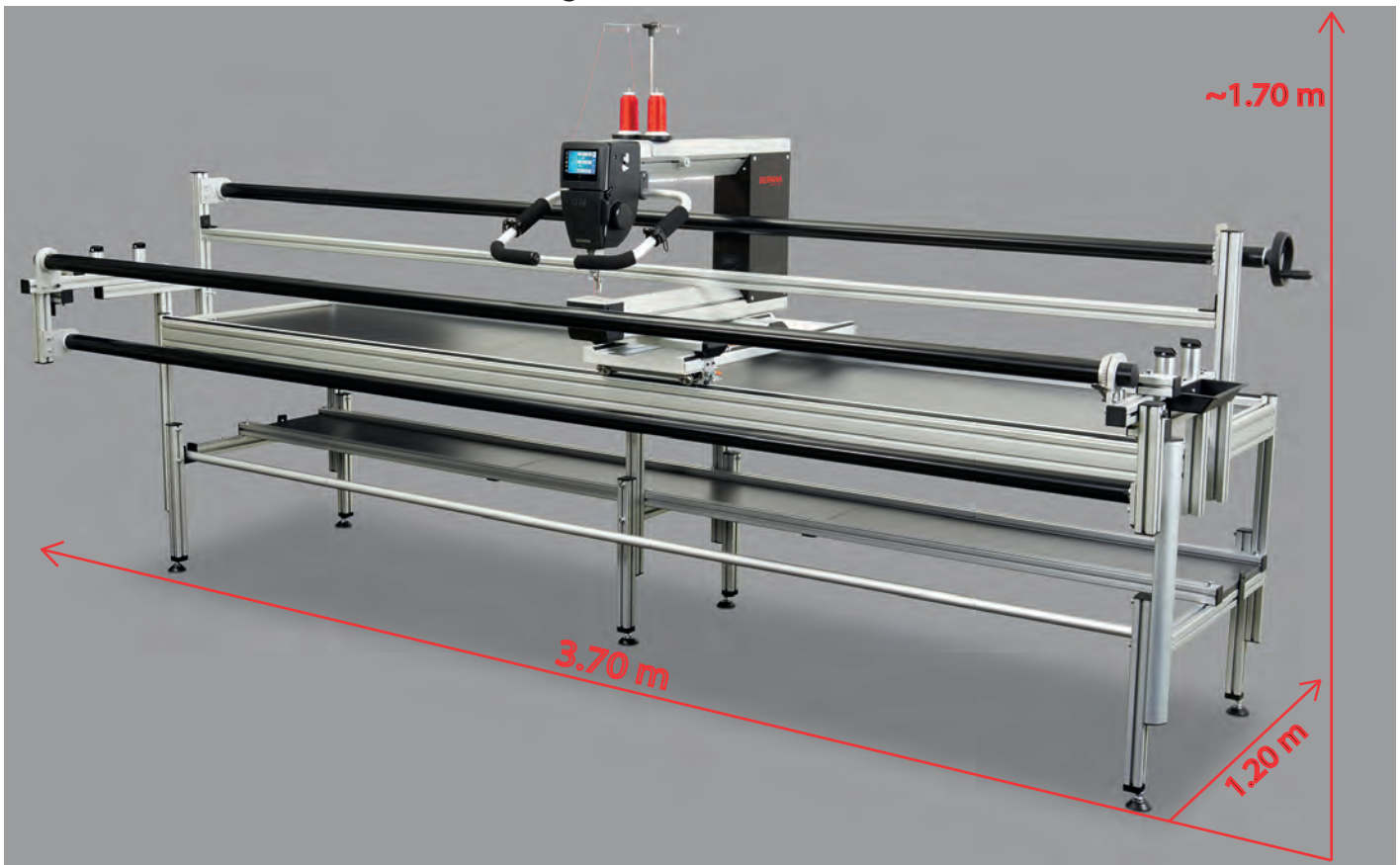

Delivery content Frame

Further details can be found in the instruction manual «Assembly of the Frame».

- 3 Legs
- 3 Bars
- 2 Rail support
- 2 Guide rails
- Carriage
- 3 Rails
- Dead bar
- 3 Table tops
- 4 Side clamps (Plastic with rubber band)
- 3 Leader
- Double-sided adhesive tape
- 2 plastic bags with small parts

1.9 Table

Overview concerning sizes



* = extended.

Delivery content Table

Further details can be found in the instruction manual «Assembly of the Table».

- 2 Leg elements
- Table top elements
- 3 Connecting elements
- 2 Exptension leaves
- Small parts and assembly tools

1.10 Overview Sewing menu Q 24 / Q 20 Frame version

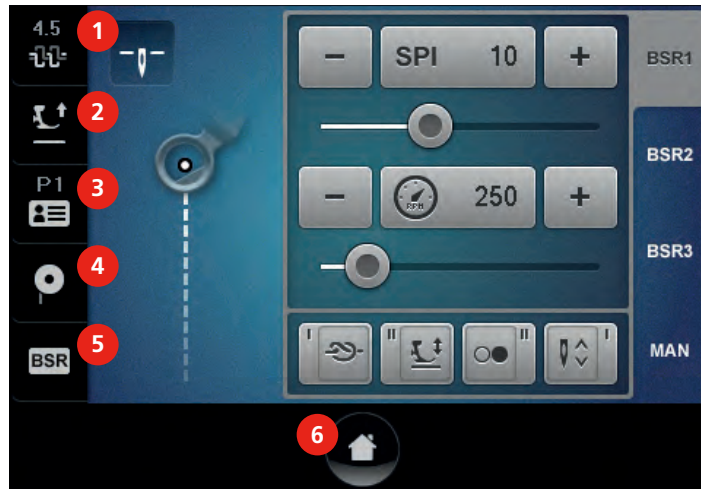

- | | | | |
|---|-----------------------|---|------------------------------|
| 1 | Upper thread tension | 4 | Filling bobbin thread |
| 2 | Presser foot position | 5 | BSR Status (active/inactive) |
| 3 | User profiles | 6 | Home |

1.11 Overview Sewing menu Q 20 Table version

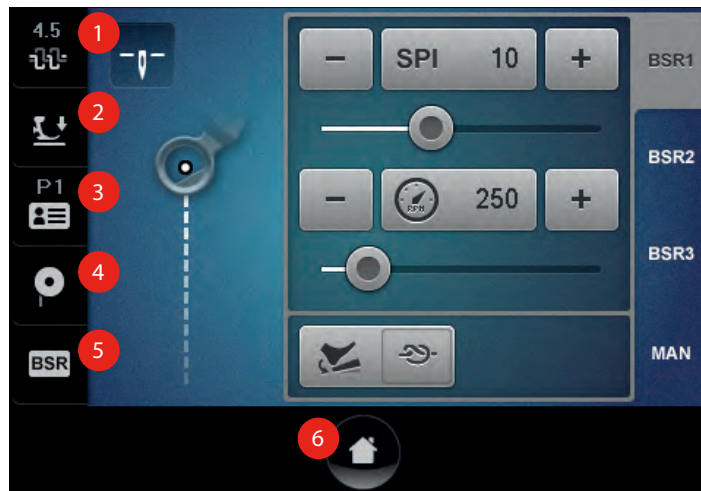

- | | | | |
|---|-----------------------|---|------------------------------|
| 1 | Upper thread tension | 4 | Filling bobbin thread |
| 2 | Presser foot position | 5 | BSR Status (active/inactive) |
| 3 | User profiles | 6 | Home |

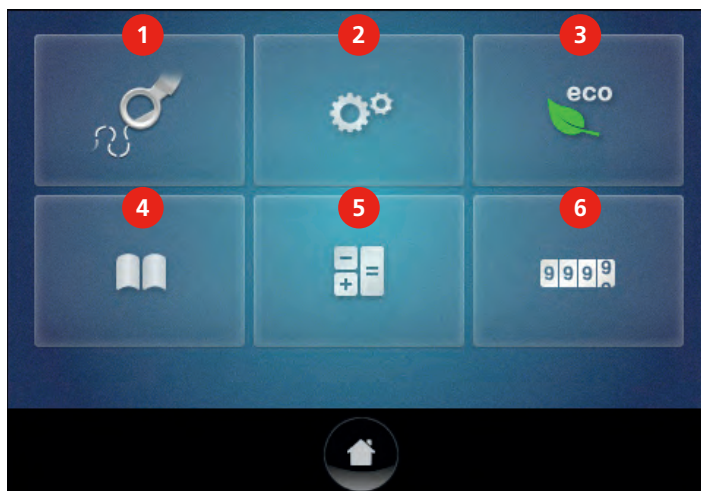

1.12 Overview Selection menu



- | | | | |
|---|---------------|---|----------------|
| 1 | Sewing menu | 4 | Tutorial |
| 2 | Setup-Program | 5 | Calculator |
| 3 | Eco mode | 6 | Stitch counter |

1.13 Buttons and icons

Icon	Name	Purpose
	Close	The window is closed and the previously made adjustments are saved.
	Confirm	Confirms the previously adjusted settings. The window is closed.
	Cancel	The process is canceled. The window is closed and the previously made adjustments are not saved.
 	Icons «-/+»	By touching the icons «-» and «+» the setting values are changed.





Icon	Name	Purpose
	Slide	By moving the slide, the setting values are changed.
	Switch	Activates or deactivates functions.
	Process navigation	By means of the history navigation you can scroll back in the display.

1.14 Needle, Thread, Fabric

Quilting on Longarm machines wears out the needle quickly. Therefore it should be replaced regularly, at least for every new quilting project. Only a perfect point results in a good stitching result. In general it can be said: the thinner the thread, the finer the needle.

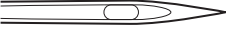
- Sizes 80 for thin threads.
- Sizes 90, 100 for medium threads.
- Sizes 110 and 120 for heavy threads.

Needle types

Illustration	Needle description	Needle description
	Universal 130/705 H/60-100	Average point, slightly rounded
	Quilting 130/705 H-Q/75-90	Fine point
	SUK needle 130/705 H-SUK/70-90	Large eye, slight ball point
	Cordonnet/Topstitch 130/705 H-N/80-100	Small ball point, long eye
	Double needle 130/705 H-ZWI/70-100	Needle distance: 1.0/1.6/2.0/2.5/3.0/4.0

Thread selection



We recommend purchasing quality threads produced by renowned manufacturers. To achieve good quilting results, only explicit quilting threads should be used and neither embroidery threads nor any other threads.

For a perfect sewing result, thread and fabric quality play an important role.

For quilting on a Longarm Machine, four thread types are generally used:

- A high quality cotton thread, which can withstand the high speed of Longarm quilting, is made from Egyptian cotton. It is mainly available in sizes 40 wt and 50 wt. The higher the wt value, the thinner the thread.
- There is a wide choice of polyester threads available for Longarm quilting. Generally it is stronger than cotton thread and is mainly offered in sizes 30 wt, 40 wt, 50 wt and 60 wt. The higher the wt value, the thinner the thread. The fine polyester threads (50 wt and 60 wt) are suitable to be used as bobbin threads and are also available as pre-wound bobbins.
- Metallic threads are used to achieve special effects. When working with metallic threads a larger needle must be used.
- Silk threads are available in a wide range of sizes: 30 wt, 40 wt, 60 wt and 100 wt. The higher the wt value, the thinner the thread. Silk threads are suitable for quilting on the Sit-Down Machine whereas their use on the Frame Machines is mostly for microwork and fine fillers.

Example for needle description

The 130/705 system, which is the most common for household machines, is explained by the following picture of a quilting needle.

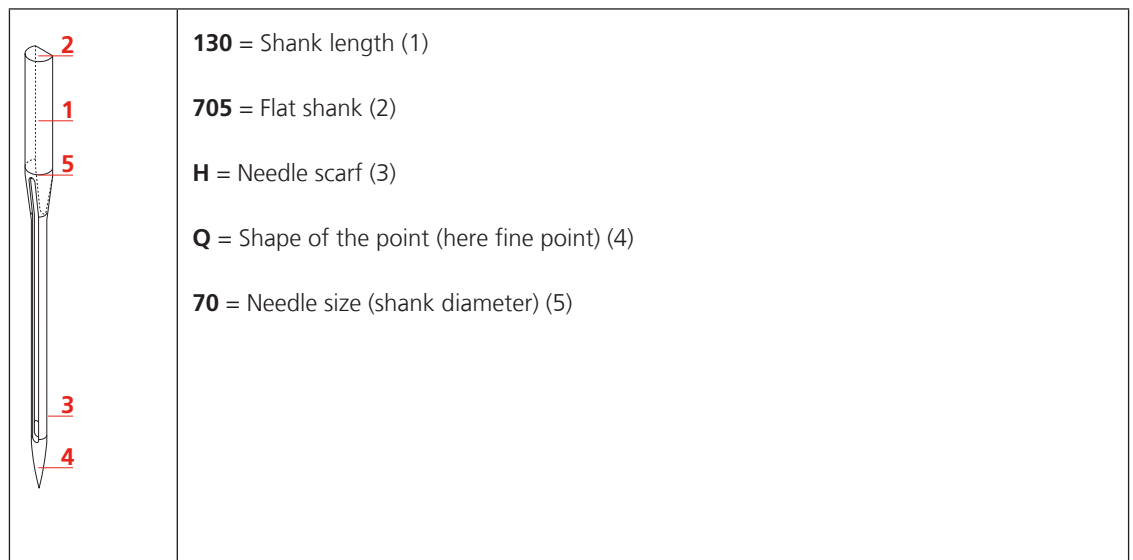

Needle/thread combination

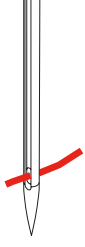
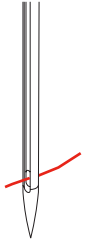
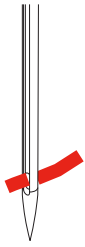
	<p>The needle/thread combination is correct, when the thread fits perfectly into the long groove and goes easily through the needle eye. The thread can be optimally sewn.</p>
	<p>The thread can break and skipped stitches can occur when there is too much clearance in the long groove and the needle eye.</p>
	<p>The thread can break and get stuck when the thread scrapes against the edge of the long groove not fit well into the needle eye optimally.</p>

2 Overview Frame and Table

2.1 Overall view Frame



Detailed information concerning the assembly of the Frame can be found in the separate assembly instruction.

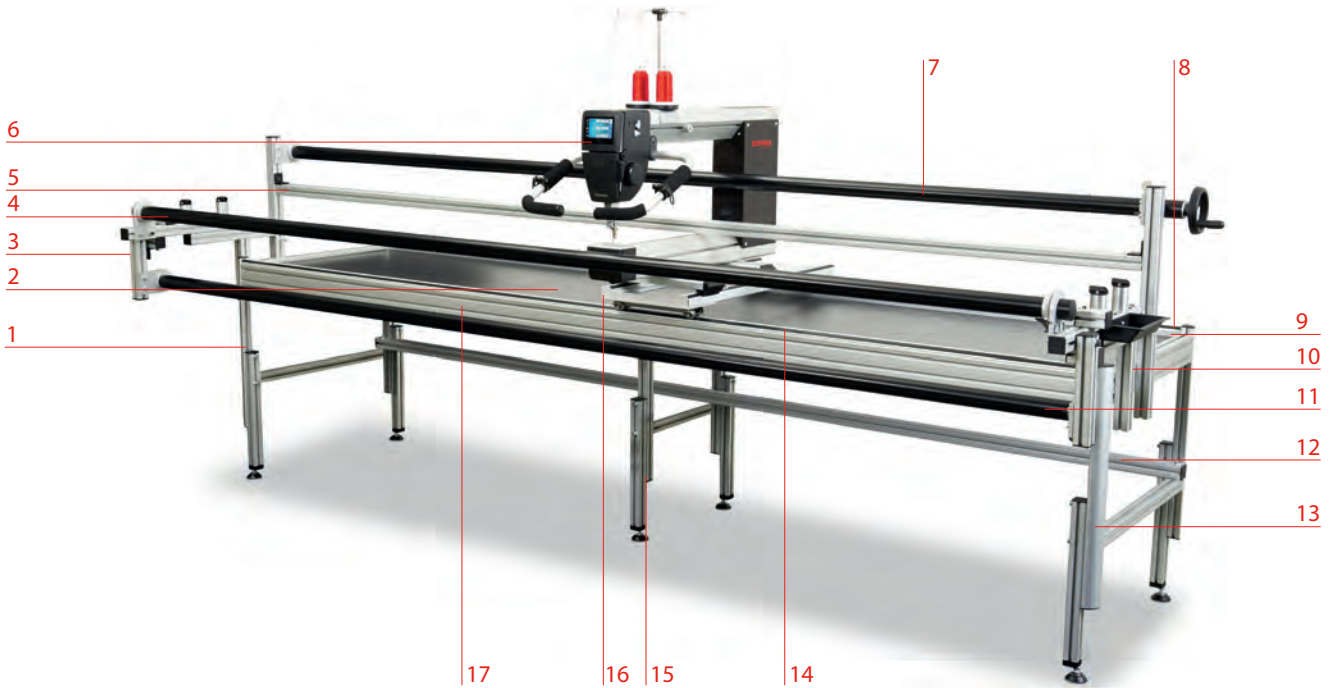

- | | | | |
|---|-------------------|----|--------------------|
| 1 | Left legs | 10 | Right rail support |
| 2 | Table tops | 11 | Top rail |
| 3 | Left rail support | 12 | Lower bar |
| 4 | Backing rail | 13 | Right legs |
| 5 | Dead bar | 14 | Guide rails |
| 6 | Machine | 15 | Middle legs |
| 7 | Take-up rail | 16 | Carriage |
| 8 | Tracks | 17 | Front bar |
| 9 | Back bar | | |

2.2 Overall view Table



Detailed information concerning the assembly of the Table can be found in the separate assembly instruction.



- | | | | |
|---|-------------------------|----|----------------------|
| 1 | Foot control | 7 | Table top |
| 2 | Connection element | 8 | Left extension leaf |
| 3 | Connection element | 9 | Machine Q 20 |
| 4 | Left leg element | 10 | Right extension leaf |
| 5 | Rear connection element | 11 | Right leg element |
| 6 | Shelf | | |

3 Preparation

3.1 Connecting the Frame machine and switching on

Attaching the front handles and adjusting the locking levers

- > Fasten the mounting support with the assembled handles to the machine (1) from beneath using the two screws.

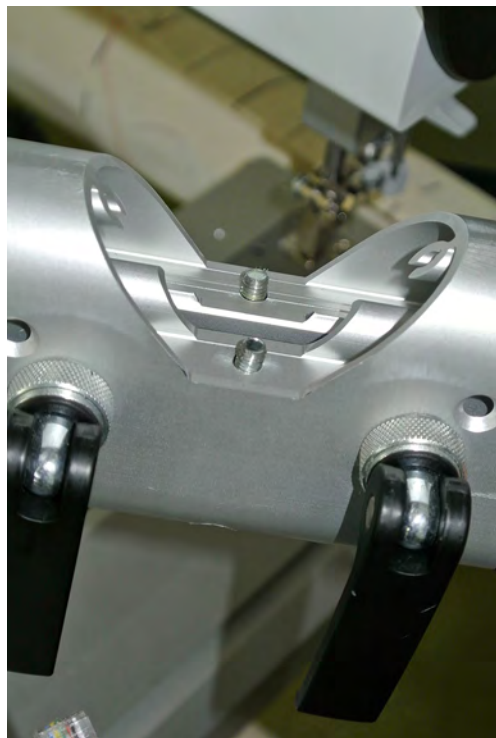

- > Insert the cable of the handles into the connection of the machine.



The locking levers at the holder for the handles always point down vertically when being clamped. This ensures that the locking levers can be opened easily and the thread won't be impeded while winding.

- > Open the locking levers.
- > Bring the two handles left and right in the desired position.



- > With the help of the fine tuning adjustment (1) the clamping zone can be adjusted so that the handles are tight when the locking levers are closed pointing downwards.



Adjusting the handles

- > Open the locking levers.



- > Adjust the handles to the desired position.
- > Close the locking levers.

Connecting the machine

- > Insert the plug of the power cable into the outlet.

Switching the machine on

- > Switch the power switch to «I».

3.4 Spool holder

Attaching the spool holder

- > Fix the attachment with the thread guides in the slot of the thread guide bar so that the bar with the two guides (1) is placed above the left spool pin (2).

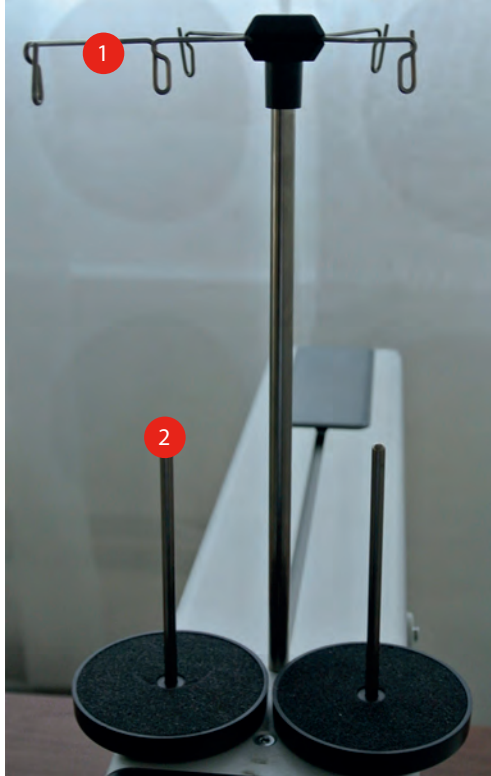

- > By using the torx screwdriver T25, turn the screw so that the nut (1) can be fitted into the groove.

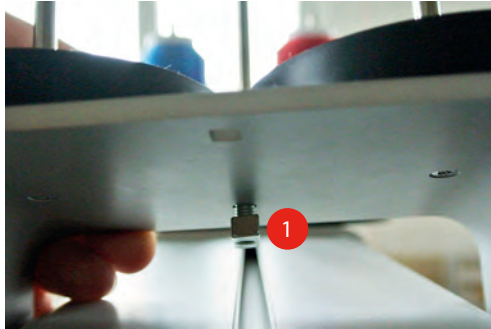

- > Place the complete spool holder on the longarm of the machine so that both spool pins (1) are positioned in front of the thread guide bar (2).

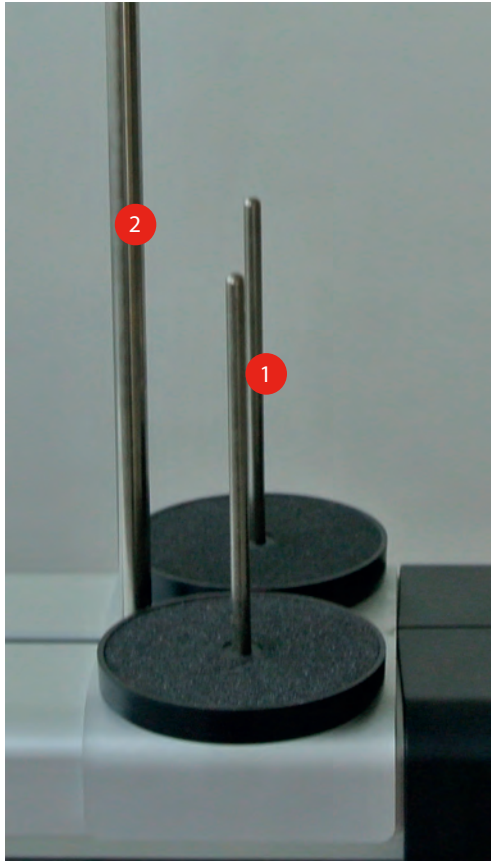

- > Move the spool holder to the front until it fits closely with the housing of the machine.
- > Tighten the screw (1) using the torx screwdriver T25.



Positioning the spool disc

The spool disc supports a regular unwinding of the thread from the thread spool and also stabilizes a small thread spool on the vertical spool pin.

- > Place the thread spool on the vertical spool pin.
- > Position the spool disc on the vertical spool pin so that there is no clearance between the spool disc and the thread spool.
- > As for the horizontal spool pin (optional accessory), place a spool disc first.
- > Place the thread spool on the spool pin.

- > Position the second spool disc on the horizontal spool pin (optional accessory) so that there is a little clearance between the spool discs and the thread spool. The thread spool needs to twist slightly while the thread is unwound so that the thread tension is not affected.

Using a spool net

Spool nets provide an even unwinding of the upper thread from the thread spool and prevent the thread from breaking when it hooks in at the edge of the thread spool.

- > Place the thread spool on the spool pin.
- > Pull the red spool net over a small thread spool.
- > Pull the white spool net over a large thread spool.

3.5 Presser foot

Setting the presser foot position



Touching the presser foot symbol on the left portion of the display, the presser foot lowers or raises.



- > Touch the icon «Presser foot position» to lower the presser foot.



- > Touch the icon «Presser foot position» again to raise the presser foot.

Changing the presser foot

- > Raise the needle.
- > Raise the presser foot.
- > Switch the machine off and disconnect it from the power supply system.
- > Push the fixing lever up.



- > Remove the presser foot.
- > Insert the new presser foot from below onto the holder.
- > Push the fixing lever down.

- > Press the stitch plate down at the right back corner until it flips up.



- > Remove the stitch plate.
- > Position the openings of the new stitch plate above the BSR lenses and press down until it engages.

3.7 Threading

Threading preparation



Thread spools with crosswise-wound thread are placed on the vertical spool pin, thread spool with parallel-wound thread are placed on the horizontal spool pin (optional accessory).

- > Raise the needle.
- > Raise the presser foot.
- > Switch the machine off and disconnect it from the power supply system.

Threading the upper thread

- > Place the thread spool on the vertical spool pin or on the horizontal spool pin (Optional accessory).
- > Hook the thread vertically into the overlaying loop of the thread guide bar and then hook it into the front left loop of the thread guide bar.
- > Bring the thread through the upper left guide and pull the thread in arrow direction through the lower thread guide.



- > Pull the thread downward in direction of the arrow through the thread regulator (1), lead the thread upward and thread it from the right to the left into the take-up lever (2), then pull it downward.

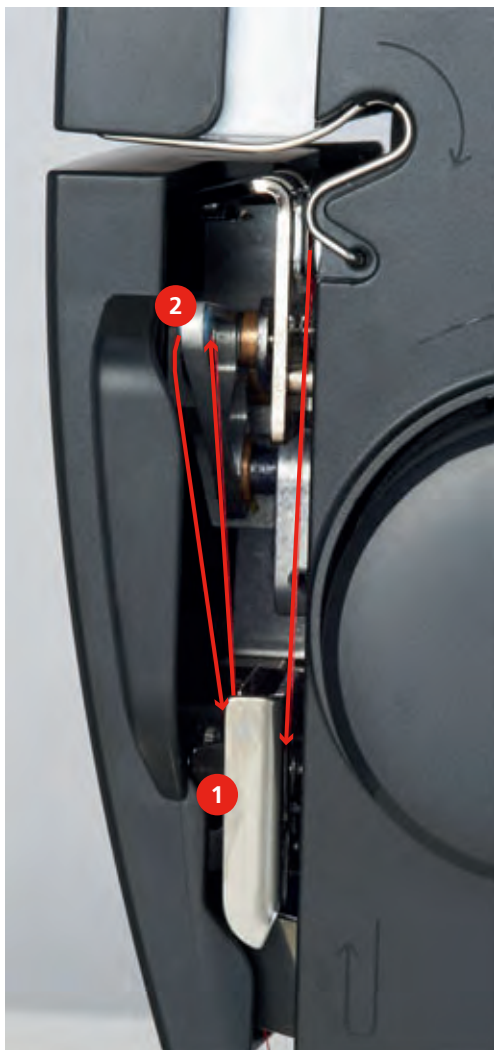

- > Guide the thread downwards into the slot of the thread guide (1) beneath the front cover and insert it into the thread guide at the needle holder (2) from the right.
- > Pull the thread to the left and press the lever of the threader down and keep pressed.

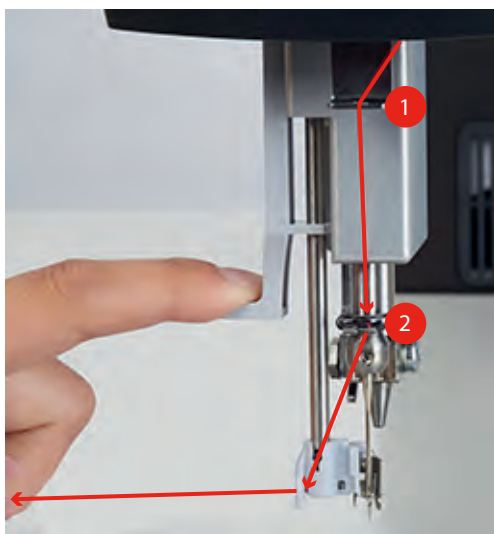

- > Pull the thread over the thread cutter from the back to the front and cut.

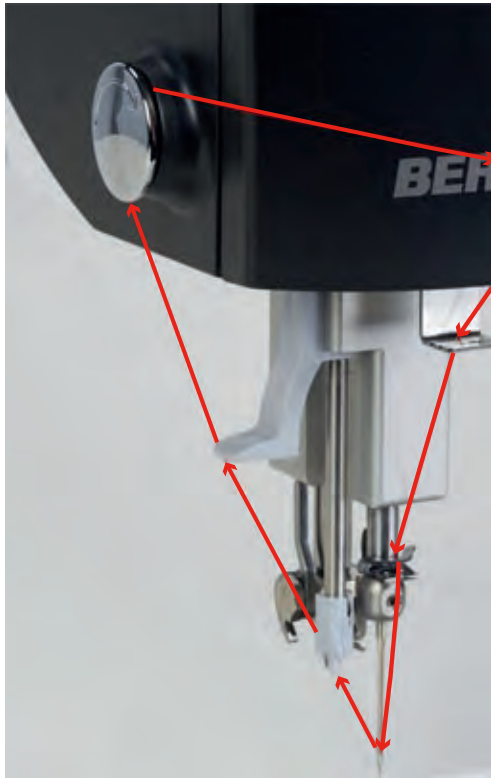

Threading the double needle (optional accessory)

When working with the double needle, it is recommended to use the Ruler foot No. 96 (Optional accessory) and the stitch plate Double needle (Optional accessory).

Prerequisite:

- The double needle is attached.
- > Place a thread spool on both, the left and the right spool pin.

- > Hook the thread vertically into the overlaying loop of the thread guide bar and then hook it into the front left loop of the thread guide bar.

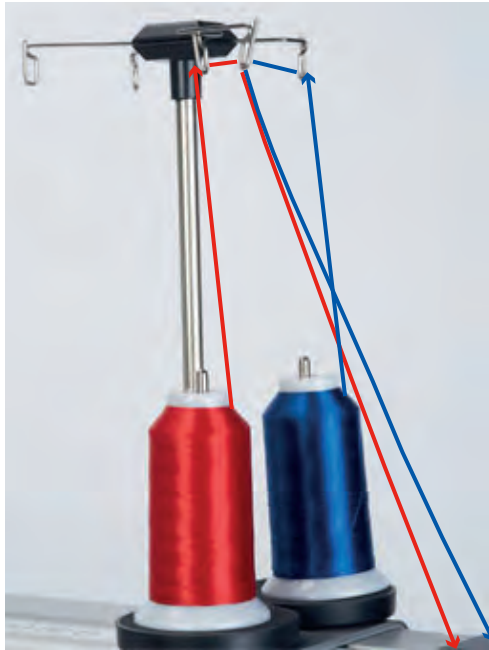

- > Bring the thread of the left thread spool through the upper left guide and the thread of the right thread spool through the upper right guide.
- > Pull the threads in arrow direction through the lower thread guide.

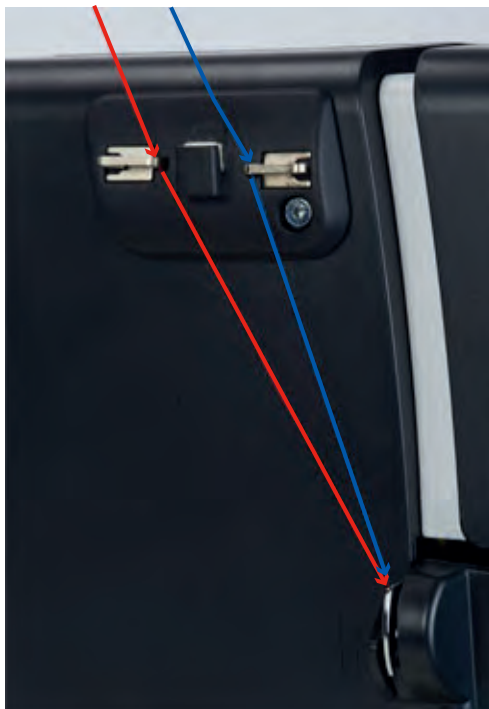

- > Open the front cover.
- > Pull the thread of the left thread spool to the right and lay it **behind** the thread tension disc of the upper thread tension.
- > Pull the thread of the right thread spool to the right and lay it **in front of** the thread tension disc of the upper thread tension.
- > Close the front cover.
- > Pull the threads downwards and pull them through the thread regulator.

- > Bring the threads upwards and thread the thread take-up lever from the back to the front.
- > Guide the threads down and insert each a thread into the left resp. into the right hole of the thread guide (1) beneath the front cover.
- > Insert the threads into the thread guide at the needle holder from the right.
- > Thread one thread through the left and one thread through the right thread guide (2).

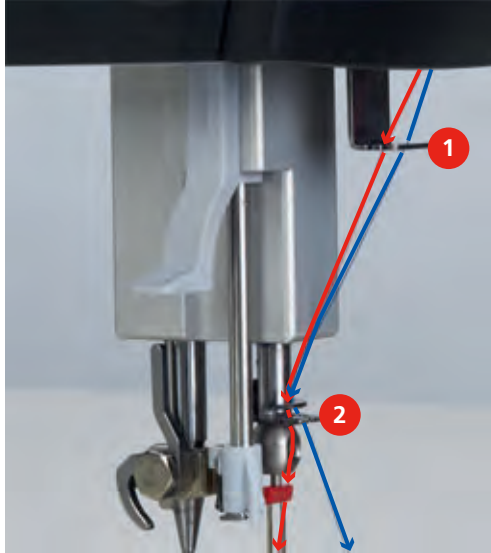

- > Place the thread into the slot of the manual threader.

- > Pull the excess thread over the thread cutter at the engaging lever (2) and cut.



- > Push the engaging lever against the bobbin.

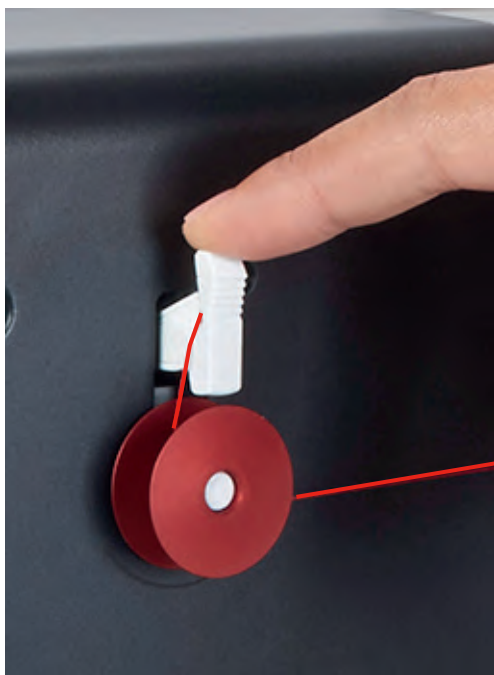

- The machine winds and the display for winding appears.
- > Adjust the winding speed with the icons «-»/«+» or by moving the slide.
 - When the bobbin is full, the winding process stops automatically.
- > Remove the bobbin and cut the thread using the thread cutter at the engaging lever.

Setting the bobbin thread tension

The bobbin thread tension should be checked every time when the bobbin thread is changed. The recommended bobbin thread tension is 220 mN.

- > Hold the bobbin case with the latch.
- > Insert the bobbin into the measuring device so that the cam of the latch is between the two guides of the measuring device.
- > Insert the bobbin case until it engages.



- > Lead the thread along the thread guide.



- > Pull the thread and check the thread tension.



- > Turn the screw at the bobbin to the left to reduce the thread tension.
- > Turn the screw at the bobbin to the right to increase the thread tension.

- > Fix the overhanging thread with the finger and cut with the thread cutter.



Threading the bobbin thread

- > Open the bobbin cover.
- > Hold the latch of the bobbin case.
- > Remove the bobbin case.
- > Remove the bobbin from the bobbin case.



- > Insert the new bobbin so that the labeling on the bobbin is visible.
- > Pull the thread into the slot of the bobbin from the right.

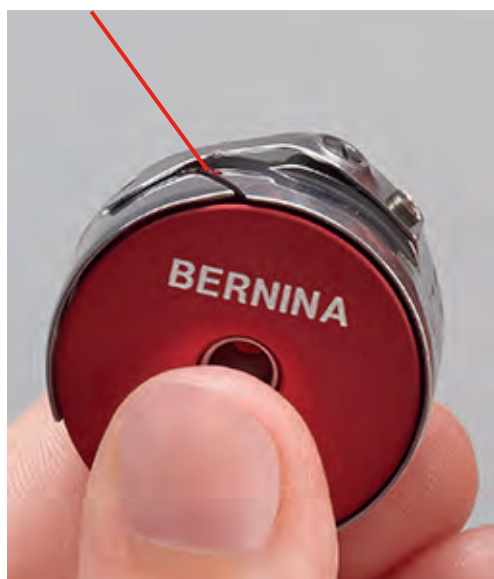

- > Pull the thread to the left below the spring and into the opening at the end of the spring.
- > Pull the thread and make sure that the bobbin rotates clockwise.



- > Hold the bobbin case with the latch.
- > Insert the bobbin case until it engages.
- > Pull the thread over the thread cutter and cut.

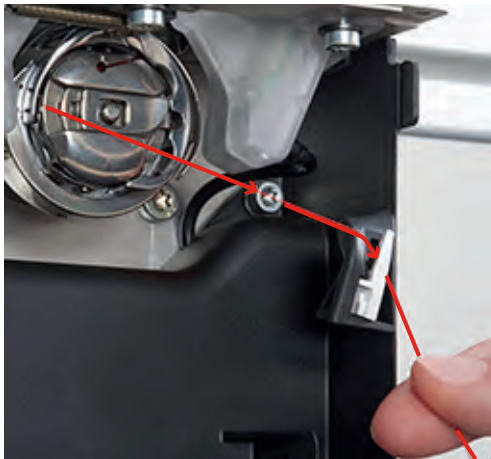

- > Close the bobbin door.

Indicating/adjusting the filling level of the bobbin thread



- > Touch the icon «Filling level of bobbin thread».
- > Touch upper icon (Yards on full Bobbin).
- > Enter the printed amount of thread in yards with purchased bobbins.

- > With self-wound BERNINA bobbins find the information in the attached chart (see page 83).

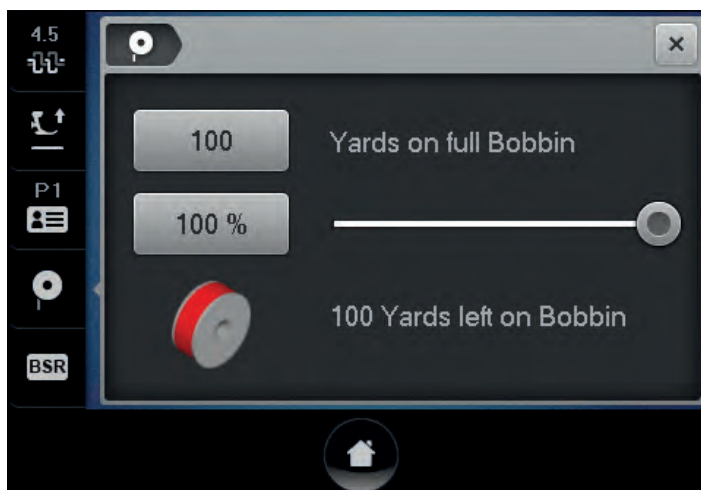

- > Touch the icon «Confirm».
 - While quilting, the display of the percentage range runs backwards.
 - As soon as the displayed percentage is below 25%, a flashing symbol in the icon «Check Filling level of bobbin thread» appears.

3.8 Calling up the Help



- > Touch the window in the display where help is needed.
- > Touch the icon «Home» twice in quick succession to start the help mode.
- > Touch the icon in the display where help is needed.
 - Assistance concerning the selected icon is displayed.

3.9 Calling up the Tutorial

The tutorial provides information and explanations on different sections concerning quilting and the machine.

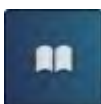

- > Touch the icon «Tutorial».
- > Select the desired topic to get information.

> Touch the text box above the color settings.

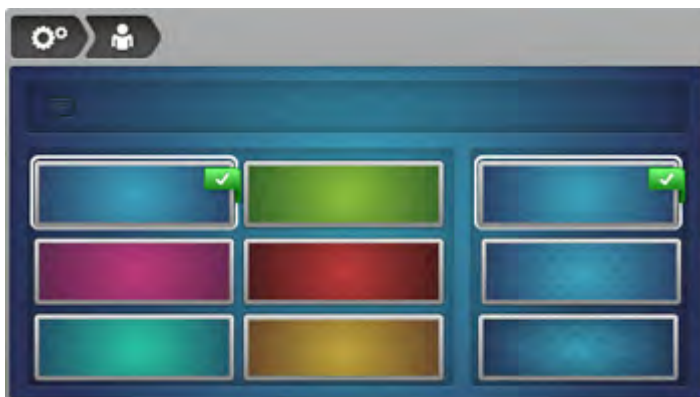

> Enter the welcoming text.



> Touch the icon «ABC» (standard setting) to use upper case letters.



> Touch the icon «abc» to use lower-case letters.

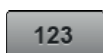

> Touch the icon «123» to use figures and mathematical symbols.

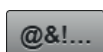

> Touch the icon «@&!» to use special characters.

> Touch the text box above the keyboard to delete the entered text completely.



> Touch the icon «DEL» to delete individual syllables of the entered text.



> Touch the icon «Confirm».

4.4 Monitoring functions

Activating the upper thread indicator



> Touch the icon «Home».

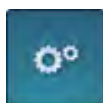

> Touch the icon «Setup Program».



> Touch the icon «Monitoring settings».

> Touch the switch in the upper portion of the display to deactivate the upper thread indicator.

- > In the section (2) touch the icon «Loudspeaker» again to activate the signal for the selection of functions.
- > In the section (3) touch the icon «Loudspeaker» to deactivate the audio and the visual signal when using the the BSR modes.
- > In the section (3) touch the icon «Loudspeaker» again to activate the audio and the visual signal when using the the BSR modes.



4.6 Machine settings

Overview Machine settings

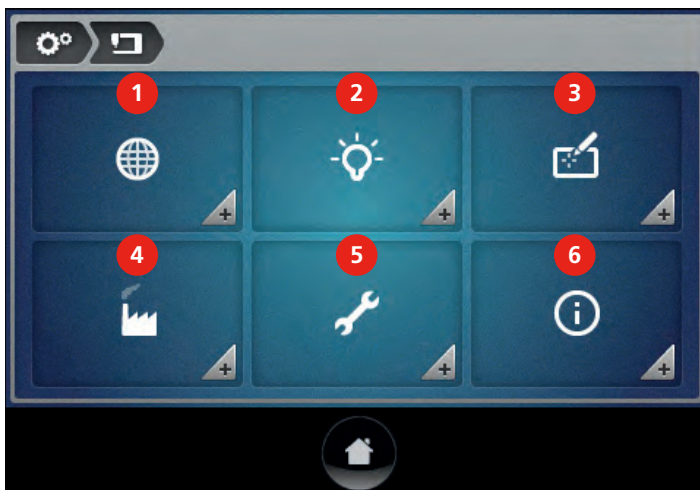

- | | | | |
|---|---------------------|---|--------------------|
| 1 | Language selection | 4 | Factory settings |
| 2 | Display settings | 5 | Maintenance/Update |
| 3 | Display calibration | 6 | Information |

Selecting the language



- > Touch the icon «Home».

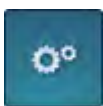

- > Touch the icon «Setup Program».

Calibrating the display

NOTICE When using a pointed item

This can damage the display.

- > Touch the display with a blunt pen.

If the display doesn't react anymore, there is a description how to open the display directly in chapter «Troubleshooting» under the title «Calibrating display can't be opened anymore».



- > Touch the icon «Home».

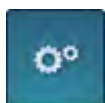

- > Touch the icon «Setup Program».



- > Touch the icon «Machine settings».



- > Touch the icon «Calibrating Display».
- > Touch the icon «Display» on the left to calibrate the front display.
- > Connect the rear display (optional accessory, only for Frame machine) to the machine.
- > Touch the icon «Display» on the right to calibrate the rear display.

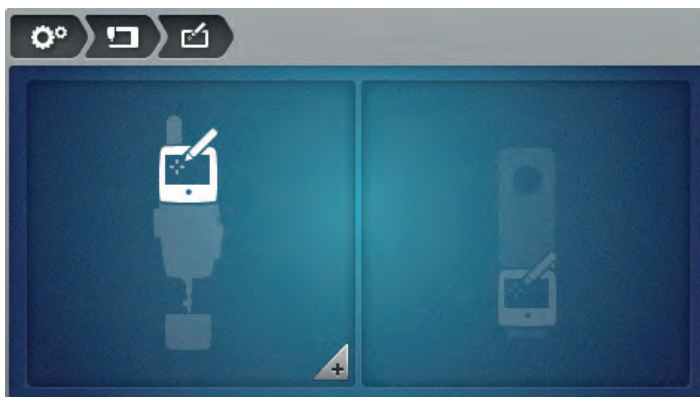

- > The crosses **must** be touched one after the other with a blunt pen so that the display can be calibrated.

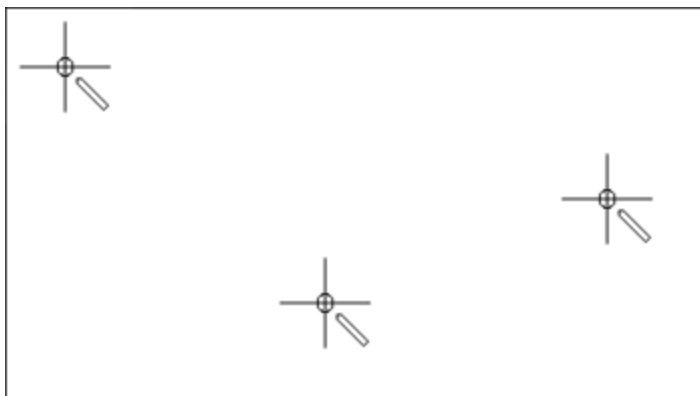

Back to basic setting



> Touch the icon «Home».

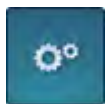

> Touch the icon «Setup Program».



> Touch the icon «Machine settings».

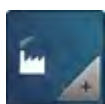

> Touch the icon «Basic setting».



> Touch the icon «Confirm».

Updating software

NOTICE BERNINA USB stick (optional accessory) has been removed too early

Data cannot be saved and the machine cannot be used.

> Remove the BERNINA USB stick (optional accessory) only after the data and settings have been saved successfully.

The latest software can be downloaded at www.bernina.com. In general, personal data and settings are transferred automatically during a software update. For reasons of safety it is recommended to save data and settings on a BERNINA USB stick (optional accessory) before the software update. If personal data and settings should get lost during an update, they can be transferred to the machine again afterwards (see page 62).

> Insert the BERNINA USB stick (optional accessory) with the latest software into the USB port (1).



> Touch the icon «Home».

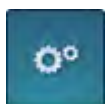

> Touch the icon «Setup Program».

Setup-Program



> Touch the icon «Machine settings».

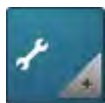

> Touch the icon «Maintenance/Update».

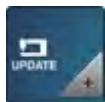

> Touch the icon «Updating machine».



> Touch the icon «Save data on USB stick» to start the saving process.



> Touch the icon «Update» to start the updating process.

Restoring saved data

NOTICE BERNINA USB stick (optional accessory) has been removed too early

Saved data cannot be transferred and the machine cannot be used.

> Remove the BERNINA USB stick (optional accessory) only after the saved data have been transferred successfully.

If personal data and settings after a software update are not available anymore, they can be transferred to the machine again afterwards.

> Insert the BERNINA USB stick (optional accessory) with the saved data and settings into USB port (1) Saving data and settings.



> Touch the icon «Home».

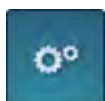

> Touch the icon «Setup Program».



> Touch the icon «Machine settings».



> Touch the icon «Maintenance/Update».

Calling up the Service-Program

With the Service Program the BERNINA service technician is able to troubleshoot and to readjust individual functions.

Along with the diagnostic instructions in the service instructions, the Service Program is accessible and usable for both, user diagnosis and remote diagnosis. The specialized BERNINA dealer can check the functions and give support for troubleshooting.



> Touch the icon «Home».

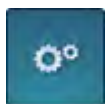

> Touch the icon «Setup Program».



> Touch the icon «Machine settings».



> Touch the icon «Maintenance/Update».



> Touch the icon «Service Program».

> Settings can be made in the Service Program according to the service instructions.



Verifying the software version



> Touch the icon «Home».

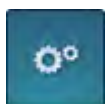

> Touch the icon «Setup Program».



> Touch the icon «Machine settings».



> Touch the icon «Information».



- > Touch the icon «Internet» to enter the Internet homepage or the email address of the specialized BERNINA dealer.

Saving Service data

Service data concerning the present status quo of the machine can be saved on a BERNINA USB Stick (optional accessory) and delivered to the specialized BERNINA dealer this way.

- > Insert a BERNINA USB stick (optional accessory) which provides enough free memory space into the USB port (1).



- > Touch the icon «Home».



- > Touch the icon «Setup Program».



- > Touch the icon «Machine settings».



- > Touch the icon «Information».



- > Touch the icon «Service data».



- > Touch the icon «LOG».
 - The icon turns dark and is outlined in white.
- > Remove the USB stick as soon as the icon turns gray again.

5 Quilting on the Frame machine

5.1 BSR Function

The speed of the machine is controlled by the movement of the machine. The faster the machine is moved, the higher the sewing speed of the machine. As soon as the maximum speed of the machine is exceeded, an audio signal sounds and the display turns red when the beeper is activated in the Setup Program.

BSR 1 mode is activated by default. This mode provides a programmed basic speed and the machine keeps running for a few seconds, even if the machine isn't moved anymore. BSR 2 mode does not run at a programmed basic speed and stops immediately after the fabric isn't moved anymore. BSR 2 mode is recommended for all work with plexiglass templates (optional accessory). BSR 3 mode is used for basting. The manual mode is used for quilting without any BSR mode.

BSR1



- | | | | |
|---|---------------------------------|---|-----------------------|
| 1 | Needle stop up/down (permanent) | 3 | BSR1 |
| 2 | Stitches per inch | 4 | Basic stitching speed |

Quilting in BSR1 mode

This mode provides a programmed basic speed and the machine keeps running for a few seconds even if the machine is not moved anymore.



- > Touch the icon «BSR1».
- > Hold the upper thread.
- > Press the button «Securing» quickly.
 - The presser foot is lowered.
 - The machine sews one stitch whereby the lower thread is brought up.
 - The presser foot is raised.
- > Hold the upper thread and the bobbin thread in place together.
- > Keep the button «Securing» pressed.
 - The presser foot is lowered.
 - The securing stitches are sewn.
- > Press the button «Start/Stop».
 - The indicator field «BSR» in the display is highlighted in green.
- > Move the machine via the handles to start the BSR mode.

- > The faster the machine is moved, the higher the speed.
- > Don't move the machine.
 - The machine keeps running at the programmed basic stitching speed.
- > Push the button «Start/Stop» or don't move the machine for about 7 seconds.
 - The BSR mode is deactivated automatically.

BSR2



- | | | | |
|---|---------------------------------|---|------|
| 1 | Needle stop up/down (permanent) | 3 | BSR2 |
| 2 | Stitches per inch | | |

Quilting in BSR2 mode

When the machine isn't moved, it stops with the programmed needle stop position up/down.
This is the recommended mode for Ruler work.



- > Touch the icon «BSR2».
- > Hold the upper thread.
- > Press the button «Securing» quickly.
 - The presser foot is lowered.
 - The machine sews one stitch whereby the lower thread is brought up.
 - The presser foot is raised.
- > Hold the upper thread and the bobbin thread in place together.
- > Keep the button «Securing» pressed.
 - The presser foot is lowered.
 - The securing stitches are sewn.
- > Press the button «Start/Stop».
 - The indicator field «BSR» in the display is highlighted in green.
- > Move the machine via the handles to start the BSR mode.
- > The faster the machine is moved, the higher the speed.
- > Don't move the machine.
 - The machine stops.
- > Push the button «Start/Stop» or don't move the machine for about 7 seconds.
 - The BSR mode is deactivated automatically.

Manual mode

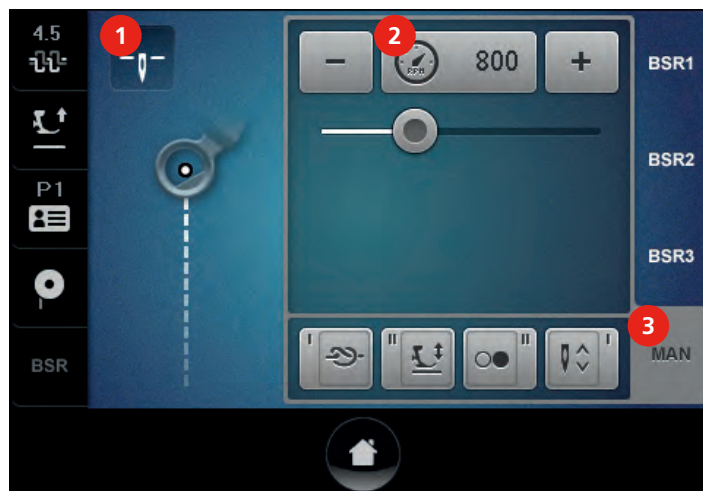

- | | | | |
|---|---------------------------------|---|-------------|
| 1 | Needle stop up/down (permanent) | 3 | Manual mode |
| 2 | Basic stitching speed | | |

Quilting in the manual mode

This mode is used for free motion quilting without automatically regulated stitch lengths.



- > Touch the icon «MAN».
- > Hold the upper thread.
- > Press the button «Securing» quickly.
 - The presser foot is lowered.
 - The machine sews one stitch whereby the lower thread is brought up.
 - The presser foot is raised.
- > Hold the upper thread and the bobbin thread in place together.
- > Keep the button «Securing» pressed.
 - The securing stitches are sewn.
- > Push the button «Start/Stop».
 - The machine runs at the programmed basic stitching speed. Standard = 800 S/min.
- > Move the machine with the handles.
- > Push the button «Start/Stop».
 - The machine stops.

5.2 Programmable functions

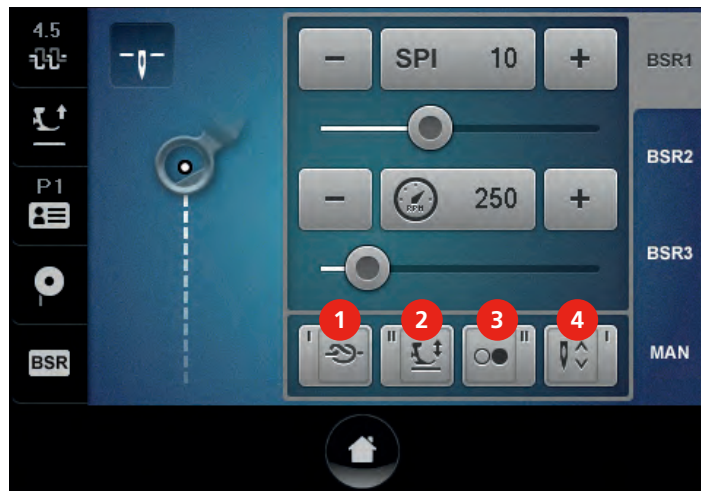

- | | | | |
|---|---------------------|---|----------------------|
| 1 | Icon I right handle | 3 | Icon II right handle |
| 2 | Icon II left handle | 4 | Icon I right handle |



- | | | | |
|---|-----------------------------|---|--------------------------------------|
| 1 | No function | 5 | Presser foot up/down |
| 2 | Start/Stop | 6 | Reducing the basic stitching speed |
| 3 | Securing | 7 | Increasing the basic stitching speed |
| 4 | Raising/Lowering the needle | | |

Programming the handle buttons

The buttons «I» and «II» at the left handle as well as the buttons «II» and «I» at the right handle can be programmed individually with different functions. Overview of the available functions.

- > Touch the icon «I» for the left handle.
- > Select the function.
- > Touch the icon «II» for the left handle.
- > Select the function.
- > Touch the icon «II» for the right handle.
- > Select the function.
- > Touch the icon «I» for the right handle.
- > Select the function.

Programming no function

- > Touch the icon for «Handle button».
- > Touch the icon «No Function».
 - The button programmed with this function is deactivated.



Starting/Stopping the machine

- > Touch the icon for «Handle button».
- > Touch the icon «Start/Stop».
 - The button programmed with this function starts or stops the machine.



Sewing securing stitches

- > Touch the icon for «Handle button».
- > Touch the icon «Securing stitches».
 - The button programmed with this function sews the securing stitches.



Raising/Lowering the needle

- > Touch the icon for «Handle button».
- > Touch the icon «Needle up/down».
 - The button programmed with this function rises or lowers the needle.



Presser foot up/down

- > Touch the icon for «Handle button».
- > Touch the icon «Presser foot up/down».
 - The button programmed with this function lowers or rises the presser foot.



Reducing the basic stitching speed

- > Touch the icon for «Handle button».
- > Touch the icon «Reducing basic stitching speed».
 - The button programmed with this function reduces the basic stitching speed.



Increasing the basic stitching speed

- > Touch the icon for «Handle button».
- > Touch the icon «Increasing basic stitching speed».
 - The button programmed with this function increases the basic stitching speed.



5.3 Adjusting the upper thread tension

- > Touch the icon «Upper thread tension».
- > Move the slide with the finger or touch the icons «-» or «+» to reduce or increase the upper thread tension.
 - The basic setting remains visible by the point marked in white.



- > Touch the yellow-framed icon to reset any changes to basic setting.



5.4 Creating a user profile



- > Touch the icon «User profile».



- > Touch the icon «+».
- > Adjust the upper thread tension.
- > Define the number of stitches per inch in the BSR1 and BSR2 modes.
- > Determine the minimum basic stitching speed for BSR1 mode.
- > Determine the minimum basic stitching speed for the manual mode.



- > Touch the icon «Confirm».
- > Enter a name for the profile.



- > Touch the icon «Confirm».
- Data is saved and the display showing the profile overview appears.

A user profile can also be created as follows:

- > Alter the settings in the current BSR mode display.
- > Touch the icon «User profile».



- > Touch the icon «+».



- > Touch the icon «Confirm».
- > Enter a name for the profile.



- > Touch the icon «Confirm».
- Data is saved and the display showing the profile overview appears.

5.5 Deleting a user profile

A standard user profile is permanent which cannot be deleted.



- > Touch the icon «User profile».



- > Touch the icon «i» of the profile to be deleted.



- > Touch the icon «Delete».
 - The selected profile is deleted and the display showing the profile overview appears.

5.6 Using the calculator

The calculator can be used for the calculation of the quilt size (cm² / square inch) as well as for the calculation of quilt patterns or the number of possible rows of a pantograph (optional accessory).



- > Touch the icon «Home».



- > Touch the icon «Calculator».

5.7 Resetting the stitch counter to 0

Due to the stitch counter the number of stitches of a quilt can be counted.



- > Touch the icon «Home».



- > Touch the icon «Stitch counter».
 - The number of sewn stitches is displayed.



- > Touch the icon «Reset».

5.8 Using the eco mode

During a longer interruption of work the machine can be set into a power save mode. The power save mode also serves as child safety lock. Nothing can be selected in the display and the machine cannot be started.



- > Touch the icon «Home».

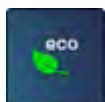

- > Touch the icon «eco».
 - The display goes to sleep. The power consumption is reduced and the sewing light is off.



- > Touch the icon «Home» again.
 - The machine is ready for use.

6 Quilting on the Table machine

6.1 BSR Function

The speed of the machine is controlled by the movement of the fabric. The faster the fabric is moved, the higher the sewing speed of the machine. As soon as the maximum speed of the machine is exceeded, an audio signal sounds and the display turns red when the beeper is activated in the Setup Program.

BSR 1 mode is activated by default. This mode provides a programmed basic speed and the machine keeps running for a few seconds, even if the machine isn't moved anymore. BSR 2 mode does not run at a programmed basic speed and stops immediately after the fabric isn't moved anymore. BSR 2 mode is recommended for all work with plexiglass templates (Optional accessory). BSR 3 mode is used for basting. The manual mode is used for quilting without any BSR mode.

BSR1



- | | | | |
|---|---------------------------------|---|-----------------------|
| 1 | Needle stop up/down (permanent) | 3 | BSR1 |
| 2 | Stitches per inch | 4 | Basic stitching speed |

Quilting in BSR1 mode



- > Touch the icon «BSR1».
- > Hold the upper thread.
- > Tip the foot control quickly with your heel.
 - The presser foot is lowered.
 - The machine sews one stitch whereby the lower thread is brought up.
 - The presser foot is raised.
- > Hold the upper thread and the bobbin thread in place together.
- > Keep the foot control pressed with the heel.
 - The presser foot is lowered.
 - The securing stitches are sewn.
- > Press the foot control down.
 - The indicator field «BSR» in the display is highlighted in green.
- > Move the fabric to start the BSR mode.
- > The faster the fabric is moved, the higher the speed.
- > Don't move the fabric.
 - The machine keeps running at the programmed basic stitching speed.
- > Release the foot control.

- > The machine stops.
 - The BSR mode is deactivated automatically.

BSR2



- | | | | |
|---|---------------------------------|---|------|
| 1 | Needle stop up/down (permanent) | 3 | BSR2 |
| 2 | Stitches per inch | | |

Quilting in BSR2 mode



- > Touch the icon «BSR2».
- > Hold the upper thread.
- > Tip the foot control quickly with your heel.
 - The presser foot is lowered.
 - The machine sews one stitch whereby the lower thread is brought up.
 - The presser foot is raised.
- > Hold the upper thread and the bobbin thread in place together.
- > Keep the foot control pressed with the heel.
 - The presser foot is lowered.
 - The securing stitches are sewn.
- > Press the foot control down.
 - The indicator field «BSR» in the display is highlighted in green.
- > Move the fabric to start the BSR mode.
- > The faster the fabric is moved, the higher the speed.
- > Don't move the fabric or release the foot control.
 - The machine stops.
 - The BSR mode is deactivated.

BSR3

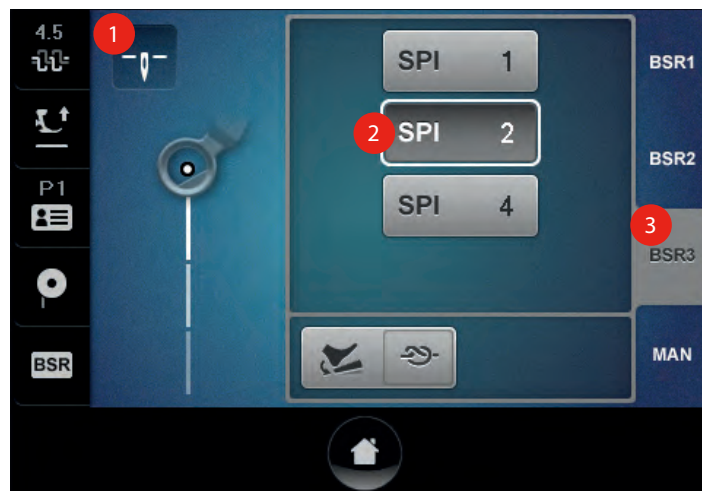

- | | | | |
|---|---------------------------------|---|------|
| 1 | Needle stop up/down (permanent) | 3 | BSR3 |
| 2 | Stitches per inch | | |

Basting in BSR3 mode



- > Touch the icon «BSR3».
- > Touch the icon «SPI» showing the desired number of stitches per inch. Standard setting = SPI 2.
- > Hold the upper thread.
- > Tip the foot control quickly with your heel.
 - The presser foot is lowered.
 - The machine sews one stitch whereby the lower thread is brought up.
 - The presser foot is raised.
- > Keep the foot control pressed with the heel (if required).
 - The presser foot is lowered.
 - The securing stitches are sewn.
- > Press the foot control down.
 - The indicator field «BSR» in the display is highlighted in green.
- > Move the fabric to sew the basting stitches.
- > Don't move the fabric or release the foot control.
- > The machine stops.
 - The BSR mode is deactivated.

Manual mode



- | | | | |
|---|---------------------------------|---|-------------|
| 1 | Needle stop up/down (permanent) | 3 | Manual mode |
| 2 | Basic stitching speed | | |

Quilting in the manual mode

This mode is used for free motion quilting without automatically regulated stitch lengths.



- > Touch the icon «MAN».
- > Hold the upper thread.
- > Tip the foot control quickly with your heel.
 - The presser foot is lowered.
 - The machine sews one stitch whereby the lower thread is brought up.
 - The presser foot is raised.
- > Hold the upper thread and the bobbin thread in place together.
- > Keep the foot control pressed with the heel.
 - The securing stitches are sewn.
- > Press the foot control down.
 - The machine runs at the programmed basic stitching speed. Standard = 800 S/min.
- > Move the fabric.
- > Release the foot control.
 - The machine stops.

Needle up-/down



- > Touch the icon for «Back kick».
- > Touch the icon «Needle up/down».
 - The back kick on the foot control raises or lowers the needle.

Presser foot up/down



- > Touch the icon «Back kick».
- > Touch the icon «Presser foot up/down».
 - The back kick on the foot control raises or lowers the presser foot.

6.3 Adjusting the upper thread tension



- > Touch the icon «Upper thread tension».
- > Move the slide with the finger or touch the icons «-» or «+» to reduce or increase the upper thread tension.
 - The basic setting remains visible by the point marked in white.
- > Touch the yellow-framed icon to reset any changes to basic setting.



6.4 Creating a user profile



- > Touch the icon «User profile».



- > Touch the icon «+».
- > Adjust the upper thread tension.
- > Define the number of stitches per inch in the BSR1 and BSR2 modes.
- > Determine the minimum basic stitching speed for BSR1 mode.
- > Determine the minimum basic stitching speed for the manual mode.



- > Touch the icon «Confirm».
- > Enter a name for the profile.



- > Touch the icon «Confirm».
 - Data is saved and the display showing the profile overview appears.

A user profile can also be created as follows:

- > Alter the settings in the current BSR mode display.
- > Touch the icon «User profile».



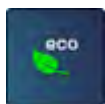

- > Touch the icon «eco».
 - The display goes to sleep. The power consumption is reduced and the sewing light is off.



- > Touch the icon «Home» again.
 - The machine is ready for use.

7 Attachment

7.1 Amount of bobbin thread

Thread	Thread type	Number of yards of a filled BERNINA bobbin	Thread size
Superior			
Bottom Line	100% Polyester	198	60
So Fine 50	100% Polyester	121	50
So Fine 40	100% Polyester	66	40
So Fine 30	100% Polyester	59	30
Fantastico	100% Polyester	107	40
Magnifico	100% Polyester	105	40
Twist	100% Polyester	109	40
King Tut	100% Cotton	94	40
Omni	100% Polyester	81	40
Lava	100% Polyester	87	35
Rainbows	100% Polyester	129	70
Kimono	Silk	236	100
Aurifil			
Aurifil variegated	100% Polyester	116	40
Aurifil	100% Cotton	92	40
YLI			
YLI	100% Cotton	58	Tex 40
Signature			
Signature	100% Cotton	65	Tex 40
Mettler			
Silk Finish #50	100% Cotton	76	50
Silk Finish #60	100% Cotton	106	60

FilTec			
Glide	100% Polyester	128	40
Cairo quilt	100% Cotton	82	40
Cairo quilt	100% Cotton	83	Tex 35/50
Wonderfil Konfetti	100% Polyester	77	50

7.2 Servicing and cleaning the machine

Cleaning the hook

CAUTION Electronically driven components

Risk of injury around the needle and the hook.

> Switch the machine off and disconnect it from the power supply system.

- > Remove the needle and the presser foot.
- > Press the stitch plate down at the right back corner until it flips up.
- > Remove the stitch plate.
- > Open the bobbin door.
- > Remove the bobbin case.
- > Remove dust, fabric and thread remnants using the brush.

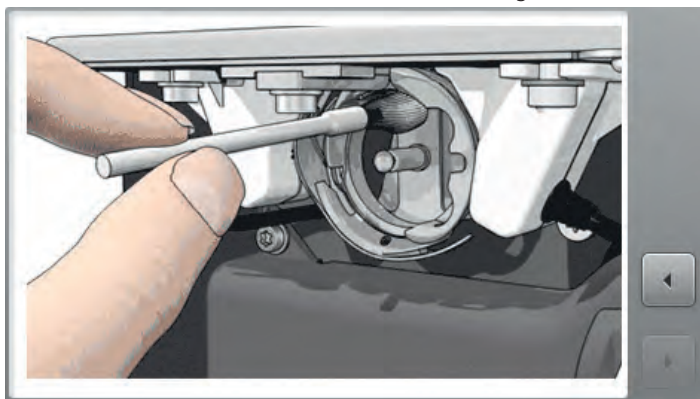

- > Insert the bobbin case.
- > Close the bobbin door.

Cleaning the bobbin case

CAUTION Electronically driven components

Risk of injury around the needle and the hook.

> Switch the machine off and disconnect it from the power supply system.

- > Open the bobbin door.
- > Remove the bobbin case.
- > Remove the bobbin from the bobbin case.
- > Remove the brake spring in the bobbin case using the red screwdriver.

- > Remove dust, fabric and thread remnants using the brush.
- > Attach the brake spring to the bobbin case so that the four cams engage in the openings.
- > Insert the bobbin into the bobbin case and thread the lower thread.
- > Insert the bobbin case.
- > Close the bobbin door.

Cleaning the display

- > Wipe the display with a soft, slightly damp microfiber cloth.

Lubricating the machine

CAUTION Electronically driven components.

Risk of injury around the needle and the hook.

- > Switch the machine off and disconnect it from the power supply system.

The machine needs to be oiled once a day resp. before every longer use.

- > Remove the presser foot and the needle.
- > Remove the stitch plate.
- > Apply 1 drop of BERNINA oil in the hook race area.

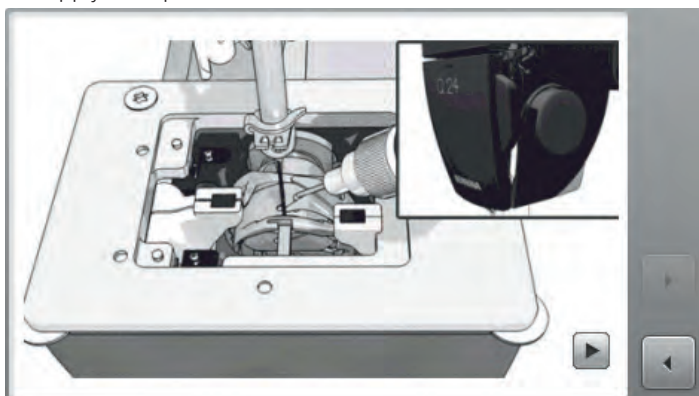

- > Turn the handwheel 2 – 3 times so that the oil is spread.
- > Attach the stitch plate.

7.3 Servicing and cleaning the Frame and the carriage

Checking and cleaning the Frame

Over time the frame may settle and the structure should be checked periodically for proper leveling.

- > Using a level, make sure the frame is level front to back and left to right.
- > As a final test, move the machine to different positions on the frame. When letting go of the machine, it should remain in the same position.
- > Level the frame accordingly.
- > Make sure all six legs are locked in place with 17 mm self-locking counter nuts.
- > The middle legs have to touch the floor. Make sure they are slightly overextended to minimize vibration of the machine and frame.
- > Check all external screws for tightness.
- > Check the 10-foot rails for buildup of debris and sticky residue.
- > Clean all four black tracks using a soapy rag then wipe them dry.

Checking and cleaning the carriage

- > Check all 16 wheels of the machine carriage for:
 - Thread buildup.
 - Free movement.
 - Sticky residue buildup on the running surface.
- > Clean the running surface of all wheels using a soapy rag then wipe them dry.
- > Check the black rails for buildup of debris and sticky residue.
- > Clean the black rails using a soapy rag then wipe them dry.
- > Check wheels for smooth X and Y movement.
- > Check that most, if not all, of the 16 wheels make contact with the black rails over their entire range of X and Y movement. Adjust the wheels accordingly (refer to the instruction manual «Assembling the Frame», chapter «Carriage and parking position - Attaching the magnets» and chapter «Attaching the rolls to the stand profiles»).

7.4 Maintenance, Cleaning and Transport Table

Cleaning and care instruction

NOTICE Inappropriate cleaning of the Table

Damages the Table.

- > Do never use oils, waxes, bleach or abrasives to clean the Table.
 - > Use a damp cloth only, if necessary mild soap and water.
-

- > Clean the Table with a damp cloth, then wipe dry. If necessary, you may use mild soap and water.





Moving or transporting the Table

- > Remove the machine before the transport.
- > When moving the Table, make sure that you always remove the extension elements of the table top first.
- > When transporting the Table in or out of your home, ask for the help of other people to teamlift or use an appropriate furniture dolly.
- > Lift by holding the base part (legs and/or base component of the table top) and never lift the top extension elements.

Failure	Cause	Troubleshooting
Upper thread breaks	Incorrect needle/thread combination.	> Match the needle with the thread size.
	The upper thread tension is too tight.	> Reduce the upper thread tension. > Check the lower thread tension using the adjustment tool (optional accessory).
	Incorrectly threaded.	> Check the upper thread.
	Poor or old thread.	> Use quality thread.
	The stitch hole or the hook tip is damaged.	> Contact your BERNINA dealer.
Lower thread breaks	Lower thread tension is too tight.	> Increase the upper thread tension or adjust the lower thread tension using the adjustment tool (optional accessory).
	Stitch hole in the stitch plate is damaged.	> Contact your BERNINA dealer.
	Needle blunt or bent.	> Use a new needle.
	Lower thread breaks.	> Check lower thread.
Needle breakage	The needle isn't fixed correctly.	> Tighten the needle fixing screw firmly.
	Poor thread with knots.	> Use quality thread.
Display doesn't react	Incorrect calibrating data.	> Re-calibrate the display.
	ECO function activated.	> Deactivate the ECO function.
Calibrating display cannot be opened	Display doesn't react.	> Switch the machine off. > Hold the finger on the display and keep pressed. > Switch the machine on.
Machine doesn't run	Power switch is on position «0».	> Switch the power switch to «I». > Contact your BERNINA dealer.
Sewing light and free arm light doesn't work	Deactivated in the Setup Program.	> Activate it in the Setup Program.
	Sewing light defect.	> Contact your BERNINA dealer.
Upper thread indicator doesn't react	Deactivated in the Setup Program.	> Activate it in the Setup Program.
Lower thread indicator doesn't react	Deactivated in the Setup Program.	> Activate it in the Setup Program.

Failure	Cause	Troubleshooting
Update error	The USB stick is not recognized.	> Use a BERNINA USB stick.
	Update process is blocked (Bottleneck stops).	> Remove the stick and switch the machine off and on again. Continue the update according the instruction.
	Update data not recognized.	> Don't save update data in a folder. > Unzip update data.

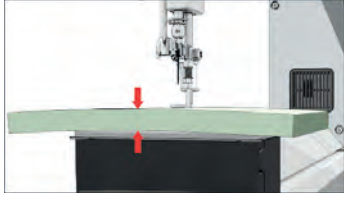
7.6 Error messages

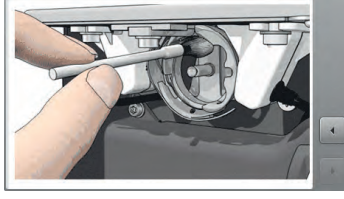
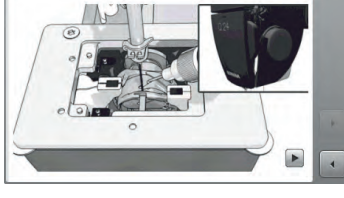
Error messages	Explanation	Troubleshooting
	The needle is not at its top end.	> Press the handwheel and turn it counterclockwise.
	Upper thread used up.	> Attach a new upper thread spool and thread.
	Lower thread indicator has reacted.	> Check the lower thread and wind a bobbin if necessary.
	Too much fabric under the presser foot.	> Reduce the fabric thickness.
	Threader is not at its top position.	> Move the threader to its top position.
 	The machine needs cleaning/lubricating.	> Clean/lubricate the machine according to the instructions. This ensures the proper functioning and a long lifespan of the machine.

Error messages	Explanation	Troubleshooting
Too less free memory capacity on the BERNINA USB stick (optional accessory).	Not enough free memory capacity on the BERNINA USB stick (optional accessory).	<ul style="list-style-type: none"> > Make sure that BERNINA USB stick (optional accessory) is used. > Delete data on the BERNINA USB stick (optional accessory).
No personal data on the BERNINA USB stick (optional accessory).	No personal data for recovery available on the BERNINA USB stick (optional accessory).	<ul style="list-style-type: none"> > Make sure that the data and settings have been saved on the BERNINA USB stick (optional accessory).
The recovery of personal data has failed.	The software update has been successful but the personal data hasn't been recovered.	<ul style="list-style-type: none"> > Make sure that the data and settings have been saved on the BERNINA USB stick (optional accessory). > Transfer saved data to the machine.
No BERNINA USB stick inserted. Make sure that the same BERNINA USB stick (optional accessory) always remains inserted during the complete automatic update.	BERNINA USB stick (optional accessory) is not inserted.	<ul style="list-style-type: none"> > Use a BERNINA USB stick (optional accessory) which provides enough free memory capacity.
The update of the software has failed.	The latest software version cannot be found on the USB stick.	<ul style="list-style-type: none"> > Make sure that the compressed ZIP file has been unpacked for the software update. > Make sure that the data for the software update have been saved directly on the data medium and not in a folder on the USB stick. > Update the software.
It is time for the periodic maintenance. Contact your dealer for an appointment.	<p>The machine needs servicing. This message appears when the programmed service interval has run out.</p> <p>Important information: Keeping the terms for cleaning and maintenance work ensures the functionality and a long lifespan. Ignoring the terms can affect the operating life and restrict the guaranteeing. The cost allocation for maintenance work is regulated nationally. Your dealer or your service center will gladly provide information.</p>	<ul style="list-style-type: none"> > Contact your BERNINA specialized dealer. > The message can be temporarily deleted by touching the icon «ESC». <p>After the third deletion, the message appears again as soon as the next service interval has expired.</p>

7.7 Storage and disposal

Storing the machine

It is recommended to store the machine in the original packaging. If the machine is stored in a cold room, place it in a warm room one hour before use.

- > Switch the machine off and disconnect it from the power supply system.
- > Don't store the machine outdoor.
- > Protect the machine against climatic influences.

Dispose of the machine

BERNINA International AG is committed to the protection of the environment. We strive to minimize the environmental impact of our products by continuously improving product design and our technology of manufacturing.

When the machine won't be used anymore, dispose this product in an environmentally responsible way according to the national directive. Do not throw away this product with your household waste. When in doubt, bring the machine to your local specialized BERNINA dealer.

- > Clean the machine.
- > Sort the components by their materials and dispose of them according to the local laws and regulations.

A

Adjusting the bobbin thread tension	51
Adjusting the handles	36
Adjusting the locking levers at the head frame	35
Assembly handles	35
Attaching the spool holder	38
Audio signals	57

B

Basic setting	61
BSR function	67, 75
BSR mode manual	70, 78
BSR1 mode	67, 75
BSR2 mode	68, 76
BSR3 mode	69, 77

C

Calculator	74, 81
Calibrating the display	60
Calling up the Help	54
Changing the needle	41
Changing the presser foot	40
Changing the stitch plate	41
Child safety lock	74, 81
Cleaning the bobbin case	84
Cleaning the display	85
Cleaning the hook	84
Connecting the foot control	37
Creating user profile	73, 80

D

Dealer details	65
Deleting user profile	73, 81
Delivery content Frame	25
Display brightness	59
Display color	55
Dispose of the machine	92

E

Eco mode	74, 81
Error messages	90

F

Filling level of bobbin thread	53
--------------------------------	----

K

Key to signs	12
--------------	----

L

Lower thread indicator	57
Lubricating the machine	85

M

Machine settings	58
Measurement of the Table	26

N

Needle position	41
Needle stop up/down permanent	41
Needle, Thread, Fabric	29
Needle/thread combination	31

P

Power save mode	74, 81
Presser foot position	40
Programmable functions	71, 79
Programming back kick on the foot control	79
Programming securing stitches	55
Programming the buttons at the handles	71
Programming the foot control	79
Programming the handle buttons	71

R

Restoring data	62
----------------	----

**DREAM
BIG**

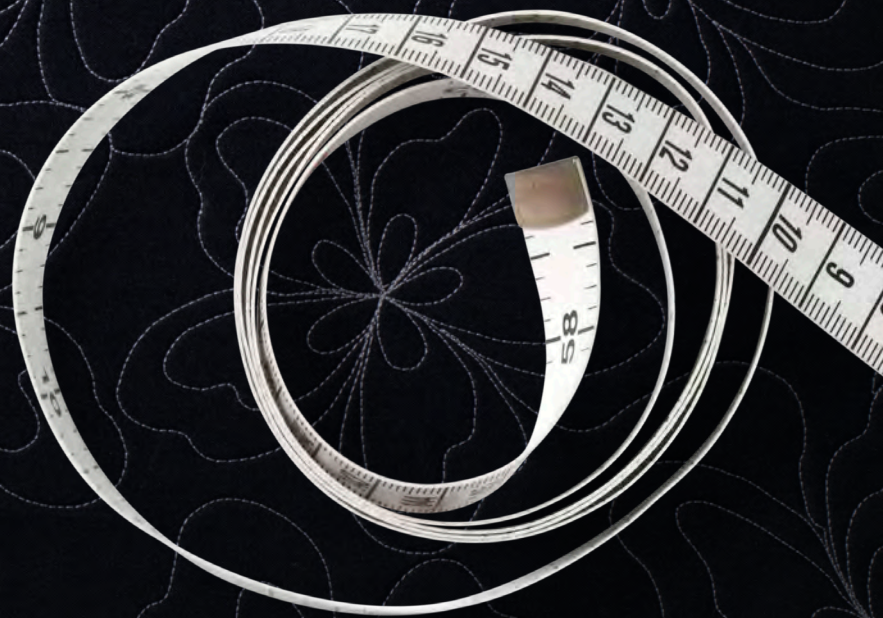

made to create **BERNINA**